



XTRA-N series

- MPPT Solar controller

User manual



Models:

**XTRA1210N/XTRA2210N
XTRA3210N/XTRA4210N
XTRA3415N/XTRA4415N**

Important safety instructions

Store the manual carefully for future reference.

This manual contains all safety, installation and operating instructions for the Maximum Power Point Tracking (MPPT) controller in the XTRA N Series (referred to in this manual as "controller").

General safety information

- Read all instructions and warnings in this manual carefully before installation.
- There is no component inside the controller that can be serviced by the user. DO NOT use the controller or attempt to repair it.
- Install the controller indoors. Do not expose the controller to the elements and prevent water from entering the controller.
- Install the controller in a well-ventilated area. The controller heatsink can get very hot during operation.
- We recommend installing suitable external fuses/circuit breakers.
- Make sure all PV panels and battery fuses/disconnects are disconnected before installing and adjusting the controller.
- All cables must be tightly connected to prevent excessive heating of loose connections.

1. General information

1.1 Overview

The XTRA-N series comes with a new design philosophy. The new charging power and current limiting function automatically ensures stability when working with oversized PV modules and when operating at higher temperatures. At the same time, it is water- and dust-resistant thanks to the IP32 protection rating and adds a professional protection chip for the communication port to further improve the controller's reliability and meet various application requirements.

By further optimizing the MPPT control algorithm, the XTRA N series can minimize the loss of the maximum power point, quickly track the maximum power point of the PV system, and extract the maximum amount of energy from the solar modules under any conditions. Furthermore, it can increase the energy utilization ratio of the solar system by 10%-30% compared to the PWM charging method.

The XTRA N series has a three-stage charging algorithm based on a digital control circuit, which can effectively extend battery life and greatly improve system performance. It also has comprehensive electronic protection against overcharging, over-discharging, or over-discharging of batteries, etc., which ensures that the solar system will be more reliable and durable. This series of controllers can be widely used for RV, communication base stations, home systems, monitoring and many other fields.

Features:

- LCD display unit XDS2
- Full-load operation with no drop in capacity over the operating temperature range
- Dustproof and waterproof design thanks to IP32 protection rating*
- Internationally recognized ST and IR brand components are used to ensure good product life due to their high quality and low defect rate
- The communication port uses a professional protection chip that can provide 5V DC power and has over-current and short circuit protection.
- Advanced Maximum Power Point Tracking Technology (MPPT) with at least 99.5% efficiency.
- Very high tracking speed and guaranteed tracking efficiency.
- Advanced MPPT control algorithm to minimize maximum power point loss and lost time
- High quality components, improving system performance with maximum efficiency up to 98%.
- Accurate detection and monitoring of MPPT performance
- Automatic limitation of charging power and current
- Wide operating voltage range of MPP.
- Compatible with lead acid and lithium batteries
- Battery temperature compensation function

- Real-time energy statistics function.
- Automatic power reduction function in case of excessive overheating
- Possibility of different modes for load
- RS-485 communication interface with Modbus protocol
- Monitoring and parameter setting via mobile phone or PC app
- Comprehensive electronic protection

★3-Dustproof: can prevent the ingress of solid foreign objects with diameter larger than 2.5mm;

2-Waterproof: when tilted to 15 degrees, it can still prevent water droplets from entering.

1.2 Characteristics



Figure 1 Product characteristics

①	RTS★ port	⑤	RS485 port
②	PV clamps	⑥	Clamp cover
③	Battery clamps	⑦	Imaging unit
④	Load clamps	⑧	Mounting hole size Φ5

★If the temperature sensor is short-circuited or damaged, the controller will charge or discharge at the default temperature setting of 25°C.

2. Installation instructions

2.1 General installation notes

- Read the entire installation instructions before installation to familiarize yourself with the installation steps.
- Use extreme caution when installing batteries, especially acid-filled lead-acid batteries. Wear eye protection and have fresh water available for rinsing and washing in case of contact with battery acid.
- Keep the battery out of reach of metal objects that could cause it to short out.
- Explosive gases may be emitted from the battery during charging, so ensure proper ventilation during charging.
- If the installation is in a housing, we strongly recommend that ventilation is provided. Never install the controller in a sealed housing with flooded batteries! Battery vapors can etch and destroy the controller's circuitry.
- Loose power connections and corroded cables can result in higher temperatures that can melt wire insulation, burn surrounding materials, or even cause a fire. Ensure tight connections and use cable clamps to secure cables and prevent them from swaying in mobile applications.
- The controller can operate with a lead acid battery and a lithium battery within its control range.
- Battery connections can be wired to a single battery or a set of batteries. The following instructions refer to a single battery, but it is assumed that the battery connection can be made to either a single battery or a set of batteries.
- Multiple identical controller models can be installed in parallel to the same set of batteries to achieve higher charging current. Each controller must have its own solar module(s).
- Select the correct cable cross section according to the current density of $5A/mm^2$.

2.2 PV system requirements

(1) Serial connection (series) of PV modules

As a basic part of a PV system, the controller can be suitable for different types of PV modules and can thus maximize the conversion of solar energy into electricity. According to the open circuit voltage (V_{oc}) and the maximum voltage point (V_{MPP}) of the MPPT controller, the combination of different types of PV modules can be calculated. The table below is for information only.

XTRA1210/2210/3210/4210N - max voltage of Voc PV module 100V:

System voltage	36 articles Voc<23V		48 articles Voc<31V		54 articles Voc<34V		60 articles Voc<38V	
	Max.	Best	Max.	Best	Ma x.	Best	Max.	Best
12V	4	2	2	1	2	1	2	1
24V	4	3	2	2	2	2	2	2
System voltage	72 articles Voc < 46 V		96 cells Voc<62 V				Voc>80 V thin film module	
	Max.	Best Shi	Max.		Best			
12V	2	1	1		1		1	
24V	2	1	1		1		1	

XTRA3415/4415N - max voltage Voc of photovoltaic module 150V:

System voltage	36 articles Voc< 23 V		48 articles Voc< 31 V		54 articles Voc< 34 V		60 articles Voc< 38 V	
	MAX.	Best	MAX.	Best	MAX.	Best	MAX.	Best
12 V	4	2	2	1	2	1	2	1
24 V	6	3	4	2	4	2	3	2
48 V	6	5	4	3	4	3	3	3

System voltage	72 cells Voc<46 V		96 cells Voc<62 V		Module with thin film Voc>80 V
	MAX.	Best	MAX.	Best	
12 V	2	1	1	1	1
24 V	3	2	2	1	1
48 V	3	2	2	2	1

NOTE: The above parameter values are calculated according to standard test conditions (STC): irradiance 1000 W/m², module temperature 25°C, air mass 1.5.

(2) Max. power of PV system

The MPPT controller has a current/power limiting function, that is, during the charging process, when the charging current or power exceeds the rated charging current or power, the controller will automatically limit the charging current or power to the rated charging current or power, which can effectively protect the charging parts of the controller and prevent the controller from being damaged due to the connection of some PV modules with overspecification. The actual function of the PV system is as follows:

Condition 1:

actual charging power of the PV system ≤ nominal charging power of the controller

Condition 2:

actual charging current of the PV system ≤ nominal charging current of the controller

When the controller operates under "**Condition 1**" or "**Condition 2**", it will perform charging according to the actual current or power; at this time, the controller can operate at the maximum power point of the PV system.



WARNING: If the PV output is not greater than the rated charging power, but the maximum voltage across the PV array disconnected circuit is greater than 100V(XTRA **10N) or 150V(XTRA **15N) (at the lowest ambient temperature), damage to the controller may occur.

Condition 3:

actual power of PV system > nominal charging power of controller

Condition 4:

actual charging current of the PV system > nominal charging current of the controller

When the controller operates under "**Condition 3**" or "**Condition 4**", it will perform charging according to the actual current or power.



WARNING: If the PV output is higher than the rated charging power but the maximum voltage across the PV array disconnected circuit is higher than 100V(XTRA **10N) or 150V(XTRA **15N) (at the lowest ambient temperature), damage to the controller may occur.

According to the "peak sunshine clock diagram", if the output of the PV system exceeds the rated charging power of the controller, the charging time is extended according to the rated power so that more energy can be obtained to charge the battery. In practice, however, the maximum output of the PV array must not exceed 1.5 times the rated charging power of the controller. If the maximum power of the PV array exceeds too much of the rated charging power of the controller, it will not only cause destruction of the PV modules, but also increase the voltage of the PV array disconnected circuit due to the effect of ambient temperature, which may cause a higher probability of damage to the controller. Therefore, it is very important to configure the system appropriately. The recommended maximum PV system output for this controller can be found in the following table

Model	Rated charging current	Rated charging performance	Max. power of PV system	Max. voltage of PV open Circuit
XTRA1210N	10A	130 W/12 V 260W/24V	195W/12V 390W/24V	92V ①
XTRA2210N	20A	260W/12V 520W/24V	390W/12V 780W/24V	
XTRA3210N	30A	390W/12V 780W/24V	580W/12V 1170W/24V	
XTRA4210N	40A	520W/12V 1040W/24V	780W/12V 1560W/24V	100V ②
XTRA3415N	30A	390W/12V 780W/24V	580W/12V 1170W/24V	150 V①

XTRA4415N	40A	520W/12V 1040W/24V 2080W/48V	780W/12V 1560W/24V 3120W/48V	138 V ^②
-----------	-----	------------------------------------	------------------------------------	--------------------

- ① At ambient temperature 25°C
- ② At minimum ambient operating temperature

2.3 Wire size

Wiring and installation shall meet current applicable electrical standards.

➤ PV wire size

As the PV system performance may vary due to PV module size, connection method or sunlight angle, the maximum conductor size can be calculated by I_{sc}

* PV systems. See I_{sc} value in PV module specification. When PV modules are connected in series, I_{sc} is equal to the I_{sc} of PV modules. When PV modules are connected in parallel, I_{sc} is equal to the sum of I_{sc} of PV modules. The I_{sc} of the PV array shall not exceed the maximum input current of the PV controller. See table below:

NOTE: All PV modules in a given system are considered identical.

* I_{sc} = short circuit current (amps) V_{oc} = voltage of the disconnected circuit.

Model	Max. PV input current	Max. size of PV wires *
XTRA1210N	10A	4mm ² /12AWG
XTRA2210N	20A	6mm ² /10AWG
XTRA3210N	30A	10mm ² /8AWG
XTRA4210N	40A	16mm ² /6AWG
XTRA3415N	30A	16mm ² /6AWG
XTRA4415N	40A	16mm ² /6AWG

* This is the maximum size of wires that will fit into the terminals of the controller.



CAUTION: When PV modules are connected in series, the open circuit voltage of the PV system must not exceed 92V (XTRA**10N) or 138V (XTRA**15N) at an ambient temperature of 25°C.

➤ Battery and load wire size

The size of the battery lead and load lead must match the rated current, see reference sizes below:

Model	Rated charging current	Rated discharge current	Battery lead size	Stress size conductor dimension

XTRA1210N	10A	10A	4mm ² /12AWG	4mm ² /12AWG
-----------	-----	-----	-------------------------	-------------------------

XTRA2210N	20A	20A	6mm ² /10AWG	6mm ² /10AWG
XTRA3210N	30A	30A	10mm ² /8AWG	10mm ² /8AWG
XTRA4210N	40A	40A	16mm ² /6AWG	16mm ² /6AWG
XTRA3415N	30A	30A	16mm ² /6AWG	16mm ² /6AWG
XTRA4415N	40A	40A	16mm ² /6AWG	16mm ² /6AWG



ATTENTION: The wire size is only informative. If there is a large distance between the PV system and the controller, or between the controller and the battery, larger conductors can be used to reduce voltage drop and thus

performance improvement.



CAUTION: The recommended wire will be selected for the battery in accordance with the condition that the battery terminals are not connected to any other inverter.

2.4 Installation



WARNING: Risk of explosion! Never install the driver in a sealed case with flooded batteries! Do not install it in confined spaces where battery fumes may accumulate.



WARNING: Risk of electric shock! When connecting solar modules, the PV generator can generate high open circuit voltages, so turn off the circuit breaker before connecting and use caution when connecting.



CAUTION : The regulator requires a minimum of 150 mm clearance above and below the regulator for proper airflow. If mounting in a housing, it is strongly recommended to provide sufficient ventilation.

Installation procedure:



Figure 2-1 Assembly

Step 1 : Determine the installation location and heat dissipation area

Installation location: the controller requires a minimum of 150 mm clearance above and below the controller for proper airflow. See Figure 2-1: Installation



CAUTION: If mounting in a housing, it is important to ensure reliable heat dissipation through the controller box.

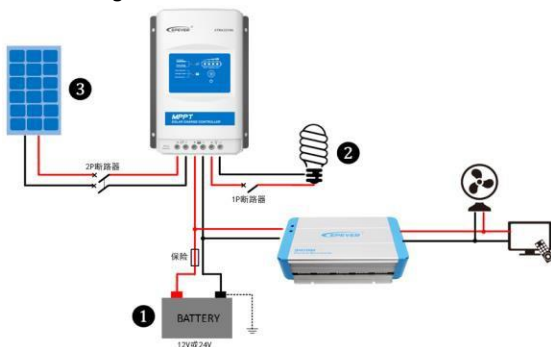

Step 2 Connect the system in the order ① battery ② load ③ PV system according to Figure 2-2 "Wiring Diagram" and disconnect the system in the reverse order ③ ②.



WARNING: When wiring the controller, do not switch the circuit breaker or activate the fuse and make sure the "+" and "-" pole wires are properly connected.



CAUTION: A fuse for a current of 1.25 to 2 times the rated current of the controller must be installed on the battery side at a distance of 150 mm or less from the battery.



CAUTION: If the controller is to be used in areas with frequent lightning or in an unprotected area, an external surge protector must be installed.



CAUTION: If the inverter is to be connected to the system, connect the inverter directly to the battery, not to the controller load.

Step 3 : Grounding

The XTRA N series is a negatively grounded controller where all or any of the negative terminals of the PV system, battery and load can be grounded simultaneously. However, depending on the practical application, all negative terminals of the PV array, battery and load need not be grounded, but the ground terminal must be grounded, which can effectively

to protect against electromagnetic interference from outside and prevent electric shock to persons caused by electricity on the jacket.



WARNING: For negatively grounded systems such as a motorhome, it is recommended to use a negatively grounded controller, but if any common positively grounded equipment is used in a common negative system and the positive electrode is grounded, there may be

damage to the controller.

Step 4 : Connect accessories

- Connect the remote temperature sensor cable



Temperature sensor

(Model:RT-MF58R47K3.81A)



Remote temperature sensor Cable (optional)

(Model:RTS300R47K3.81A)

Connect the remote remote sensor temperature sensor cable to the ① interface and place the other end near the battery.



CAUTION: If the remote temperature sensor is not connected to the controller, the default setting for charging or discharging the battery is 25°C without temperature compensation.

- Connect accessories for RS 485 communication

See chapter 4 "**Setting control parameters**".



CAUTION: RS485 The internal circuit of the communication port does not have an isolation structure, so it is recommended to connect the communication isolator to the interface before performing communication procedures.

Step 5: Power supply to the controller

Disconnecting the battery fuse circuit turns the controller on. Then check the status of the battery indicator (the controller operates normally when the indicator light is green). Disconnect the fuse and circuit breaker circuit of the load and PV system. Then the system will operate in the preset mode.





WARNING: If the controller is not functioning properly or the battery indicator on the controller shows an abnormality, refer to Section 5.2 "Troubleshooting".

3. Imaging unit

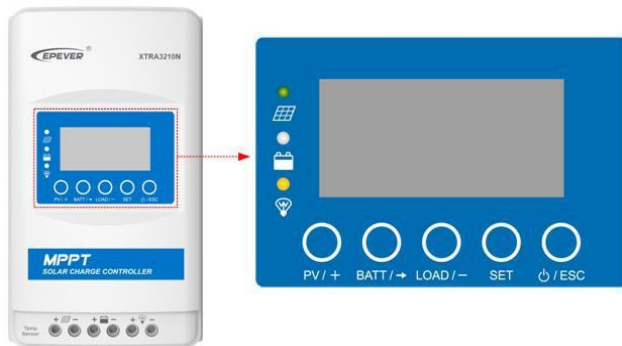
Display unit (XDS2)







(1) Indicator

Indicator	Colour	Stat us	Instru ction
	Green	Shining	PV connection normal, but low voltage (low radiation) from PV, without charging
	Green	VYP	No PV voltage (night time) or PV connection problem
	Green	Flashes slowly (1 Hz)	Charging
	Green	Fast flashing (4 Hz)	Voltage surge PV
	Green	Shining	Normal
	Green	Flashes slowly (1Hz)	Full
	Green	Fast flashing (4 Hz)	Surge
	Orange	Shining	Suspension
	Red	Shining	Excessive discharge
	Red	Flashes slowly (1Hz)	Battery overheating Lithium battery - low temperature ^①
	Yellow	Shining	ZAP load
	Yellow	VYP	Load VYP
Fast flashing PV&BATTLED			Overheating of the controller System voltage error ^②





- ① When using a lead-acid battery, the controller does not have low temperature protection.
- ② When using a lithium battery, the system voltage cannot be automatically detected

(2) Buttons

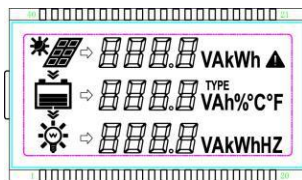
	Press the button	Browsing the PV interface Data settings +
	Press the button and hold for 5 s	LCD cycle time setting
	Press the button	Browsing the BATT interface Move the cursor during setup
	Press and hold the button for 5 seconds	Setting the battery type, battery charge status and temperature unit.
	Press the button	Browsing the controller load interface Data settings -
	Press the button and hold for 5 s	Operating load setting mode
	Press the button	Enter the settings interface
		Switch interface settings to interface browsing
		Setting the parameter as a button for input
	Press the button	Leaving the settings interface

(3) Display



Icon	Information	Icon	Information	Icon	Information
	Day	 	Without charging	 	Without discharging

☾	Night	☀️ ↓ 🔋	Charging	🔋 ↓ 💡	Discharging
---	-------	--------------	----------	-------------	-------------

1) PV parameters

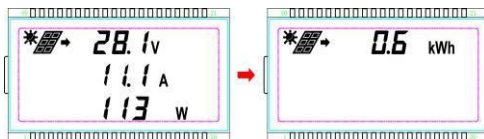

Display: voltage/current/power/energy generated

2) Battery parameters

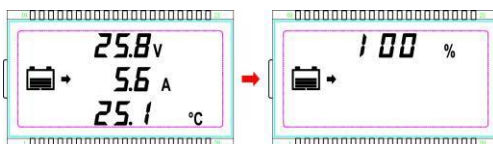

Display: voltage/current/temperature/battery charge status

3) Load parameters

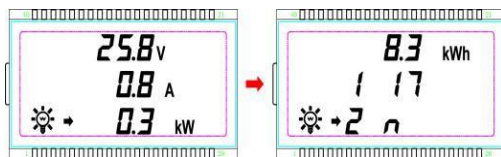

Display: voltage/current/power/energy consumption/load mode - timer 1/load mode - timer 2

(4) Settings parameters

1) Battery type

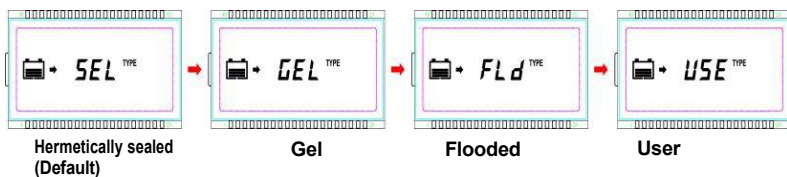

Procedure:

Step 1: Press the button for the settings interface.

Step 2: Press and hold the button for 5 seconds for the battery type interface.

Step 3: Press the button of **LOAD / -** to select the battery type.

Step 4: Press the button to confirm the selected battery type.



ATTENTION : For information about the battery voltage setting of the controller, please refer to chapter 4.1 if the battery type is User.

2) Battery capacity



Procedure:

Step 1: Press the button for the settings interface.

Step 2: Press and hold the button for 5 seconds for the battery type interface.

Step 3: Press the button for the battery capacity interface.

Step 4: Press the button of **LOAD / -** to set the battery capacity.

Step 5: Press the button to confirm the parameters.

3) Temperature units

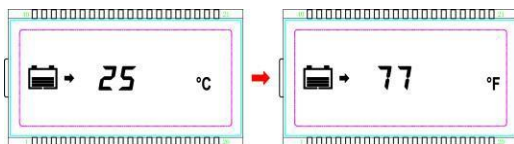

Procedure:

Step 1: Press the button for the settings interface.

Step 2: Press and hold the button for 5 seconds for the battery type interface.

Step 3: Press the button twice for the temperature unit interface.

Step 4: Press the button **PV / +** to adjust the temperature units.

Step 5: Press the button to confirm the parameters.

4) LCD cycle time

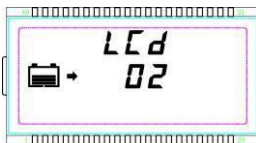

NOTE: The default LCD cycle time is 2 s, the setting time range is 0~20 s.

Procedure:

Step 1: Press the button for the settings interface.

Step 2: Press and hold the button for 5 seconds to interface the LCD cycle time.

Step 3: Press the button on **LOAD / -** to set the LCD cycle time.

Step 4: Press the button to confirm the parameters.

5) Load mode

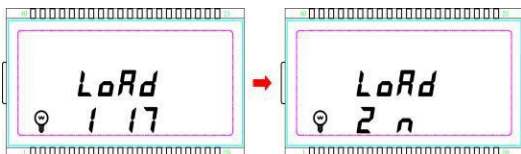

Procedure:

Step 1: Press the button for the settings interface.

Step 2: Press and hold the button for 5 seconds for the load mode setting interface.

Step 3: Press the button or **LOAD/-** to set the operating mode.

Step 4: Press the button to confirm the parameters.

NOTE: for load mode, see section 4.2.



4. Setting the control parameters

4.1 Battery types

4.1.1 Supported battery types

Item	Lead-acid batteries with acid electrolyte	Lithium battery
1	Hermetically sealed (Default)	LiFePO4(4s/12V; 8s/24V)
2	Gel	Li(NiCoMn)O2 (3s/12V; 6s/24V)
3	Flooded	User (9~34 V)
4	User (9~17V/12V; 18~34V/24V; 36~68V/48V)	



CAUTION: When selecting the default battery type, the battery voltage management parameters will be set by default and cannot be changed. To change these parameters, select the battery type

"User".

4.1.2 Battery voltage control parameters

Parameters below are for a 12 V system at 25 °C, double the values for a 24 V system

Battery type Voltage	Hermetically sealed	Gel	Flooded	User
Disconnection voltage at Surge	16.0V	16.0V	16.0V	9~17V
Charging limit voltage	15.0V	15.0V	15.0V	9~17V
Connection recovery voltage during overvoltage	15.0V	15.0V	15.0V	9~17V
Rechargeable charging Equalization	14.6V	-	14.8V	9~17V
Boost charging voltage	14.4V	14.2V	14.6V	9~17V
Charging Voltage Float	13.8V	13.8V	13.8V	9~17V
Boost charging voltage at reconnection	13.2V	13.2V	13.2V	9~17V
Low voltage at recovery Connect	12.6V	12.6V	12.6V	9~17V
Warning refresh undervoltage	12.2V	12.2V	12.2V	9~17V
Warning voltage at Unclasp	12.0V	12.0V	12.0V	9~17V

Disconnection at low Voltage	11.1V	11.1V	11.1V	9~17V
Discharge voltage limit	10.6V	10.6V	10.6V	9~17V
Length Equalization	120 min	–	120 min	0~180 min
Boost length	120 min	120 min	120 min	10~180 min



WARNING: Due to the diversity of lithium battery types, battery voltage values must be confirmed by a technician.

4.1.3 User settings

1) PC settings

- Link

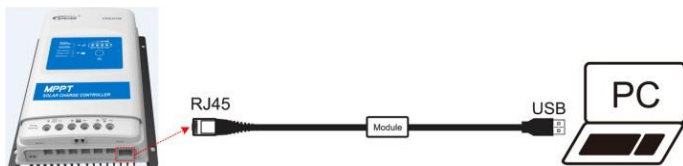

- Software Downloads

<http://www.epever.com/en/index.php/Technical/download> (PC software for solar charge controller)

2) Application software settings

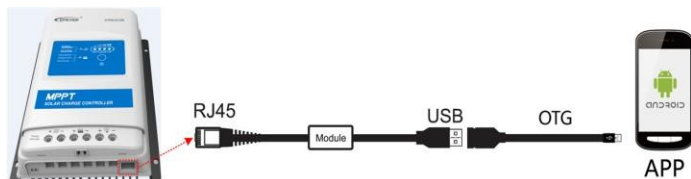

- Download software (user software for lead-acid battery)

<http://www.epever.com/en/index.php/Technical/download> (Android app for solar charge controller)

- Download software (user software for lithium battery)

<http://www.epever.com/en/index.php/Technical/download> (Android app for lithium battery for solar charge controller)

1) Setting the control voltage value

- The following rules must be observed when adjusting the parameter values for the user lead-acid battery.

- I. Disconnection voltage at overvoltage > Limit charging voltage \geq Equalization charging voltage \geq Boost charging voltage \geq Float charging voltage > Boost recovery charging voltage.
- II. Overvoltage Disconnection Voltage > Overvoltage Recovery Voltage
- III. Low voltage recovery voltage > Low voltage disconnection voltage \geq Discharge limit voltage.
- IV. Undervoltage recovery warning voltage > Undervoltage warning voltage \geq Discharge limit voltage.
- V. Boost refresh charging voltage > Low voltage on reconnection.

- The following rules must be observed when adjusting the parameter values for the user lithium battery.

- I. Overvoltage Disconnection Voltage > Overvoltage Protection (Protection Circuit Modules (PCM)) + 0.2V* ;
- II. Disconnect voltage at overvoltage > Reconnection voltage at overvoltage = Limit charging voltage \geq Equalization charging voltage = Boost charging voltage \geq Float charging voltage > Boost charging voltage at reconnection.
- III. Low voltage recovery voltage > Low voltage disconnection voltage \geq Discharge limit voltage.
- IV. Undervoltage recovery warning voltage > Undervoltage warning voltage \geq Discharge limit voltage;
- V. Boost refresh charging voltage > Low voltage on reconnection;
- VI. Overvoltage Disconnection Voltage \geq Overvoltage Protection (Protection Circuit Modules (PCM)) + 0.2 V* ;



WARNING: The required PCM accuracy must be at least 0.2 V. If the deviation is greater than 0.2 V, the manufacturer will not be responsible for any system failure caused by this error.

4.2 Load Modes

4.2.1 LCD settings

XDS2 display and control

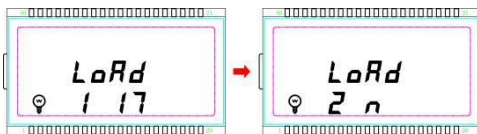

If the above interface appears on the LCD display, proceed as follows:

Step 1: Press the  button for the setup interface.

Step 2: Press and hold the  button for 5 seconds for the load mode setting interface.

Step 3: Press the button on  to set the load mode.

Step 4: Press the button to confirm the parameters.

1) Load mode

1**	Timer 1	2**	Timer 2
100	Light ON/OFF	2 n	Inactive
101	Load is switched on for 1 hour after sunset	201	Load is switched on for 1 hour before sunrise
102	Load is switched on for 2 hours after sunset	202	Load turns on for 2 hours before sunrise
103 ~ 113	The load is switched on at 3 ~ 13 hours after sunset	203 ~ 213	The load is switched on 3 ~ 13 hours before sunrise
114	Load turns on for 14 hours after sunset	214	Load is switched on for 14 hours before sunrise
115	Load turns on for 15 hours after sunset	215	Load is switched on for 15 hours before sunrise
116	Test mode	2 n	Inactive
117	Manual mode (Default load ZAP)	2 n	Inactive



NOTE: Set the Lights ON/OFF, Test Mode and Manual Mode using Timer 1. Timer 2 will be inactive and displays "2 n".

4.2.2 RS 485 communication settings

1) Load mode

- Manual control (default)

On/Off load control via push button or remote commands (e.g. application or PC software).

- Light ON/OFF

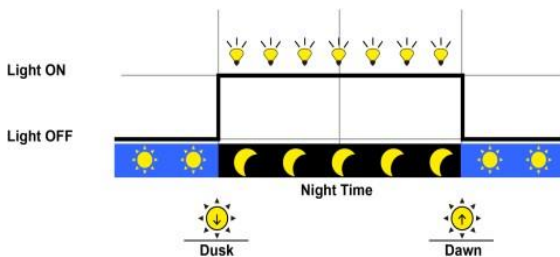

- ZAP light + timer

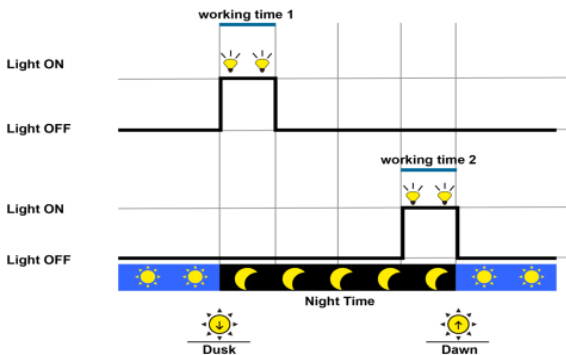

- Time management

ON/OFF load time control by setting the real time clock.

2) Load mode setting

(1) PC settings

- Link

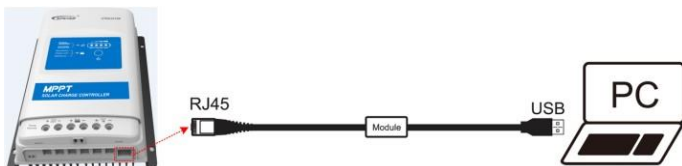

- Software Downloads

<http://www.epever.com/en/index.php/Technical/download> (PC software for solar charge controller)

(2) Application software settings

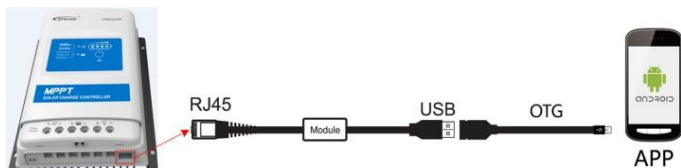

- Software download







<http://www.epever.com/en/index.php/Technical/download> (Android app for solar charge controller)

(3) MT50 settings



WARNING: For detailed setup methods, please refer to the instructions or after-sales support.

4.3 Accessories (optional)

<p>Remote temperature sensor (RTS300R47K3.81A)</p>		<p>Battery temperature sensor for temperature compensation for control parameters, standard cable length is 3 m (length can be adjusted). RTS300R47K3.81A connects to port (4.) on the controller. NOTE: If the temperature sensor is shorted or damaged, the controller will charge or discharge at the default temperature setting of 25°C.</p>
<p>USB cable RS 485 CC-USB-RS485-150U</p>		<p>A USB to RS-485 converter is used to monitor the controller using the Solar Station computer software. The cable length is 1.5 m. The CC-USB-RS485-150U connects to the RS-485 port on the controller.</p>
<p>OTG cable OTG-12CM</p>		<p>It is used to connect the controller to a mobile phone and allows real-time monitoring of the controller and parameter changes using a mobile software application.</p>
<p>Remote meter MT50</p>		<p>The MT50 can display various operational and system fault information. Information can be displayed on the backlit LCD screen, the buttons are easy to operate and the numeric display is easy to read.</p>
<p>RS 485 to Bluetooth adapter eBox-BLE-01</p>		<p>After connecting the controller to the eBox-BLE-01 using a standard Ethernet cable (parallel cable), the operating status and related controller parameters monitored in the app via Bluetooth.</p>
<p>Data logger eLOG01</p>		<p>Once the controller is connected to the eLOG-01 via the RS 485 communication cable, it can record controller operating data or monitor the operating status controller in real time using PC software.</p>
<p>NOTE: Refer to the accessory user manual for accessory settings and controls.</p>		

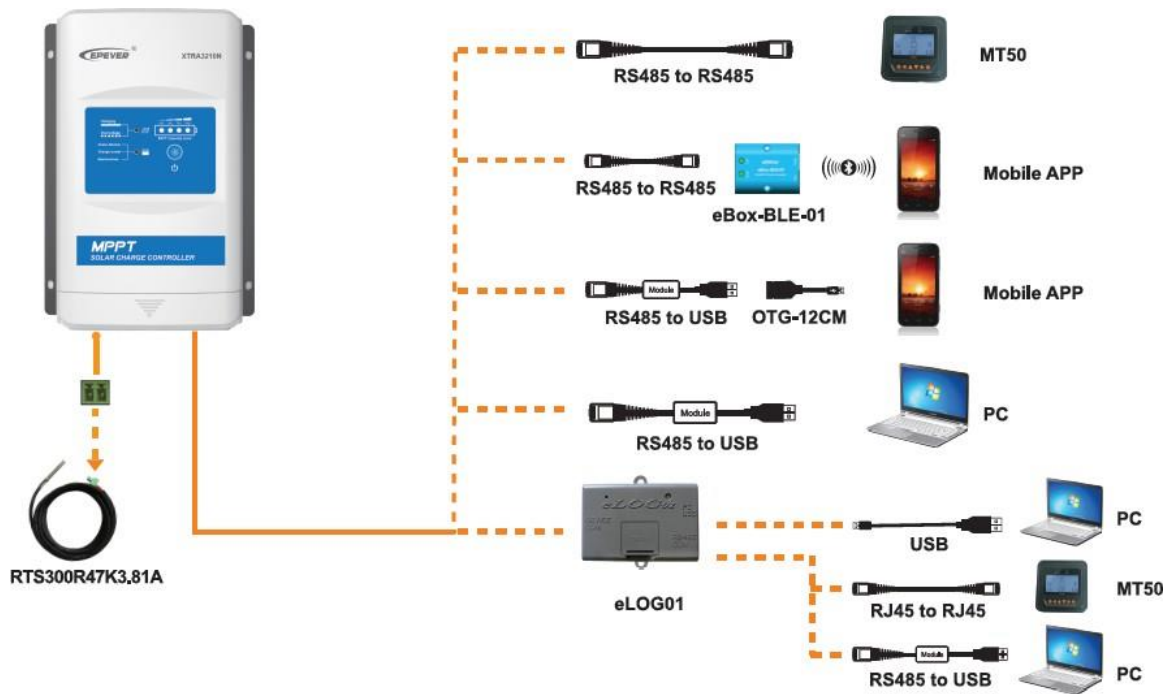

5. Protection, troubleshooting and maintenance







5.1 Protection

PV excess current/power	If the charging current or power of the PV panels exceeds the rated current or power of the controller, it will be charged at the rated current or power. NOTE: When PV modules are connected in series, make sure that the voltage of the disconnected circuit of the PV system must not exceed the maximum PV voltage of the disconnected circuit. This could damage the controller.
PV short circuit	If the controller is not in PV charging mode, the controller will not be damaged in case of a short circuit in the PV system.
PV reverse polarity	If the polarity of the PV system is reversed, the controller may not be damaged and can continue to operate normally after the polarity is correctly connected. NOTE: If the PV system is connected to the controller in reverse, it will cause 1.5 times the rated output of the controller (watts) from the PV system damage to the controller.
Night reverse charging	Prevents the battery from discharging during the night via the photovoltaic module.
Reversed battery polarity	Full protection against reversed battery polarity. The result will be zero damage to the battery. To restore normal operation, switch to the correct polarity. NOTE: Due to the characteristics of the lithium battery, if the PV connection is correct and the battery polarity is reversed, the controller is damaged.
Battery overvoltage	When the battery voltage reaches the over-voltage disconnect voltage, the battery charging will automatically stop to prevent damage to the battery caused by over-charging.
The battery is too low	When the battery voltage reaches the undervoltage disconnection voltage, the battery discharge is automatically stopped to avoid Damage to the battery caused by excessive discharge. (Any load connected to the controller will be disconnected. Loads connected directly to the battery will not be affected and may further discharge the battery.)
Battery overheating	The controller detects the battery temperature via an external temperature sensor. The controller stops working if the temperature exceeds 65 °C and resumes operation when its temperature is below 55 °C.
Lithium battery - low temperature	If the temperature detected by the optional temperature sensor is below the low temperature threshold (LTPT), the controller automatically stops charging and discharging. If the detected temperature is higher than the LTPT, the controller will operate automatically (LTPT is 0 °C by default and can be set between 10 ~ -40 °C).
Load short circuit	If the load output is short-circuited (the short-circuit current is ≥ 4 times the rated load current of the controller), the controller automatically shuts down the output. If the load reconnects the output automatically five times (delay 5 s, 10 s, 15 s, 20 s, 25 s), it must be cleared by pressing the Load button, restarting the controller or switching from night to day mode (night > 3 hours).
Load overload	If the load is overloaded (the overload current is ≥ 1.05 times the rated load current of the controller), the controller automatically shuts down the output. If the load reconnects the output automatically five times (delay 5 s, 10 s, 15 s, 20 s, 25 s), it must be cleared by pressing the Load button, restarting the controller or switching from night to day mode (night > 3 hours).
Overheating of the	The controller can detect the temperature inside the battery. The controller stops working when the temperature exceeds 85 °C and resumes operation when the temperature is below 75 °C.

controller★	
TVS High Voltage Transients	The internal circuits of the controller are equipped with transient voltage protection to allow protection against high voltage pulses with less energy. If the controller is to be used in areas with frequent lightning or in an unprotected area, it is recommended that an external surge protector be installed.

★When the internal temperature reaches 81°C, the charge power reduction mode is activated, reducing the charge power by 5%, 10%, 20% and 40% for each 1°C increase. If the internal temperature is above 85°C, the controller will stop charging. Once the temperature drops below 75 °C, the controller will resume operation.

5.2 Troubleshooting

Possible reasons	Defects	Troubleshooting
PV system disconnection	Charging LED is off during the day, even when the sun is shining properly applied to PV modules	Verify that the PV cable connection is correct and tight
Battery voltage is below 8V	The wire connections are correct, the controller is not working.	Check the battery voltage. Minimum voltage to activate the controller is 8V.
	XDS2 : Charging indicator Green flashing   The battery charge level is displayed as full, battery frame flashing, fault icon flashing	
	XDS2 : Charging indicator Lights red solid   The battery level is displayed as low, battery box flashes, fault icon flashes	
	XDS2 : Battery indicator flashing red   Battery frame flashing, fault icon flashing	
Overheating of the controller	XDS2 : PV/BATT indicator flashes rapidly	When the temperature of the controller's heat sink exceeds 85 °C, the controller automatically shuts down the input and output circuits. Once the temperature drops below 75°C, the controller will continue to operate.

System voltage error		<p>① Check whether the battery voltage matches the operating voltage of the controller.</p> <p>② Please replace with a suitable the battery or reset the operating voltage.</p>
Load overload	<p>1. Load has no output 2.XDS2 :</p>  <p>Load and fault icon flashes</p>	<p>① Reduce the number of electrical devices.</p> <p>② Restart the controller.</p> <p>③ Watch for one night-day cycle (night time > 3 hours).</p>
Load short circuit		<p>① Check the load connection carefully, clear the fault.</p> <p>② Restart the controller.</p> <p>③ Stop for one night-day cycle (night time > 3 hours).</p>

5.3 Maintenance

In order to guarantee the best performance, it is recommended to carry out the following inspections and maintenance activities at least twice a year.

- Make sure the controller is firmly installed in a clean and dry place.
- Make sure that there is nothing blocking the airflow around the controller. Remove dirt and small particles from the radiator.
- Check all exposed cables and make sure the insulation is not damaged by solarization, worn by friction, damaged by drought, insects or rats, etc. Repair or replace the cables if necessary.
- Tighten all clamps. Check for loose, damaged or burnt cable connections.
- Check and verify that the LED indication complies with the requirements. Pay attention to troubleshooting or error indication. If necessary, make appropriate corrections.
- Confirm that all system components are firmly and properly grounded.
- Confirm that no terminals show corrosion, insulation damage, signs of high temperature or scorching/ discoloration and tighten the terminal screws to the recommended tightening torque.
- Check for dirt, insect nests and corrosion. If necessary, remove everything in time.
- Check and confirm that the lightning arrester is in good condition. Replace it in time to prevent damage to the controller and other equipment.



WARNING: Risk of electric shock!

Make sure that all power is turned off before performing the above actions, and then follow the appropriate guidelines and regulations.

6. Technical specifications

Electrical parameters

Item	XTRA 1210N	XTRA 2210N	XTRA 3210N	XTRA 4210N	XTRA 3415N	XTRA 4415N
Rated system voltage	12/24VDC ^① Auto.				12/24/36/48VDC ^① Auto.	
Rated charging current	10A	20A	30A	40A	30A	40A
Rated discharge current	10A	20A	30A	40A	30A	40A
Voltage range battery	8~32V				8~68V	
Max. open circuit PV voltage	100V ^② 92V ^③					
MPP voltage range	(Battery voltage +2 V) ~ 72V				(Battery voltage +2 V) ~ 108V	
Max. power input PV	130W/12V 260W/24V	260W/12V 520W/24V	390W/12V 780W/24V	520W/12V 1040W/24V	390/12 780/24 1170/36 1560/48	520/12 1040/24 1560/36 2080/48
Self-consumption	≤35mA(12V) ≤22mA(24V)				≤35mA(12V), ≤22mA(24V) ≤16mA(12V), ≤16mA(24V)	
Discharge circuit voltage drop	≤0,23V					
Compensation coefficient ^④ temperatures	-3 mV/°C/2 V (default)					
Earthing	Negative earthing					
RS485 interface	5VDC/200mA					
LCD backlight time	60 s (default)					

①When using a lithium battery, the system voltage cannot be detected automatically.

②At minimum ambient operating temperature

③At ambient temperature 25°C

④When using a lithium battery, the temperature compensation coefficient will be 0 and cannot be changed.

Ambient parameters

Ambient temperature* (100% input and output)	-25°C~+50°C(LCD) -30°C~+50°C(No LCD)
Storage temperature range	-20°C~+70°C
Relative humidity	≤ 95% (non-condensing)

Encapsulation	IP32★
---------------	-------

◆ The controller can fully operate at operating temperature. When the internal temperature exceeds 81 °C, the charging power reduction mode is activated.

★3-Dustproof: can prevent the ingress of solid foreign objects with diameter larger than 2.5mm;

2-Waterproof: when tilted to 15 degrees, it can still prevent water droplets from entering.

Mechanical parameters

Item	XTRA1210N	XTRA2210N	XTRA3210N	XTRA4210N
Dimensions	175×143×48mm	217×158×56.5mm	230×165×63mm	255×185×67.8mm
Mounting dimensions	140×134mm	180×149mm	180×159mm	200×176mm
Size mounting hole	Φ5 mm			
Clamp	12AWG(4mm ²)	6AWG(16mm ²)	6AWG(16mm ²)	6AWG(16mm ²)
Recommended cable type	12AWG(4mm ²)	10AWG(6mm ²)	8AWG(10mm ²)	6AWG(16mm ²)
Weight	0.57kg	0.96kg	1.31kg	1.67kg

Item	XTRA 3415	XTRA4415
Dimensions	255x187x75,7	255x189x83,2
Mounting dimensions	200x178	200x180
Size mounting hole	Φ5 mm	
Clamp	6AWG(16mm ²)	6AWG(16mm ²)
Recommended cable type	6AWG(16mm ²)	6AWG(16mm ²)
Weight	2,07kg	2.47kg

Annex I Efficiency conversion curves

Illuminance: 1000W/m² Temperature: 25 °C Model:

XTRA1210N

- 1. Solar module MPP voltage (17 V, 34 V)/Minor system voltage (12 V)

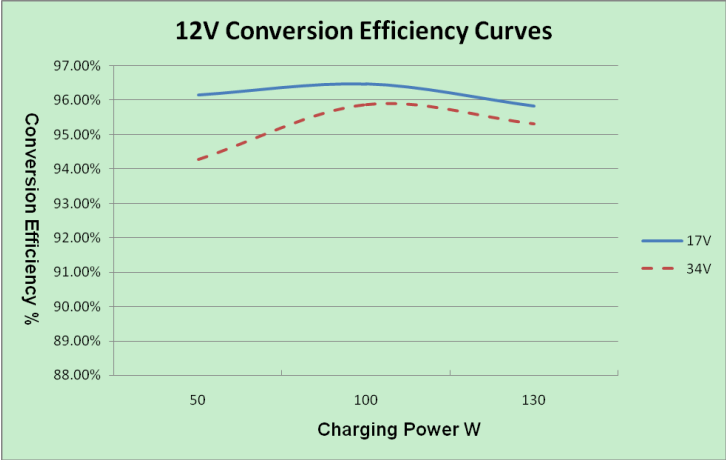

- 2. Solar module MPP voltage (34 V, 51 V, 68 V)/Invariable system voltage (24 V)

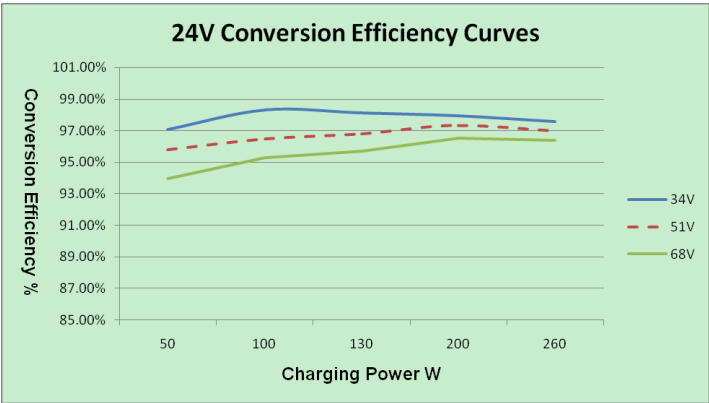

Model: XTRA2210N

1. Solar module MPP voltage (17V, 34V)/Invariable system voltage (12V)

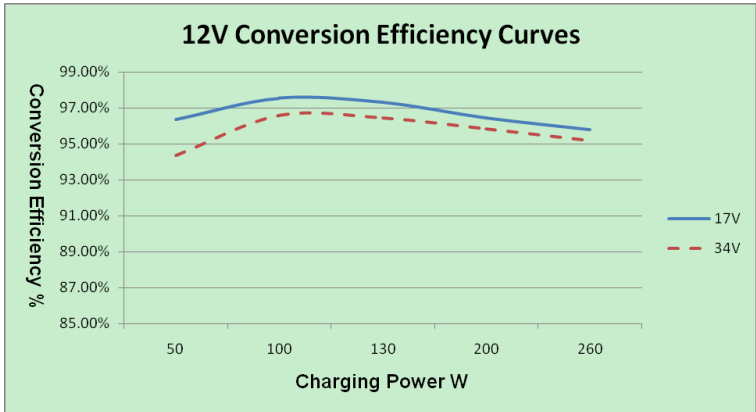

2. Solar module voltage MPP 34 V, 51 V, 68 V)/Invariable system voltage (24 V)

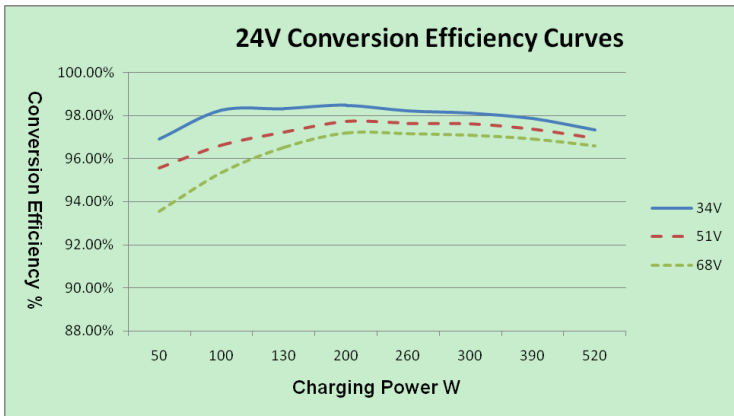

Model: XTRA3210N

1. Solar module MPP voltage (17 V, 34 V)/Minor system voltage (12 V)

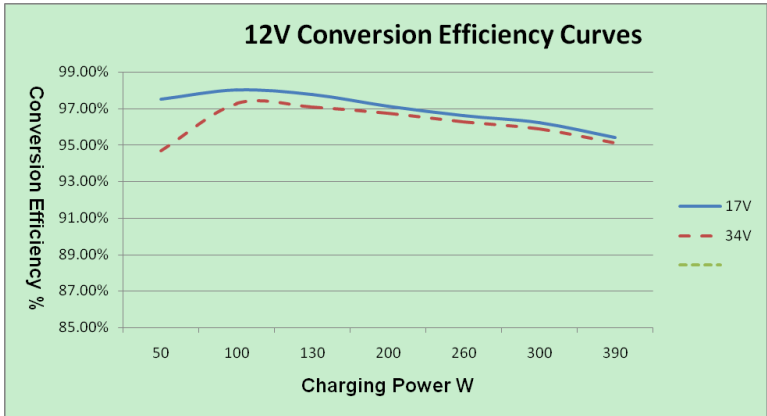

2. Solar module MPP voltage (34 V, 51 V, 68 V)/Invariable system voltage (24 V)

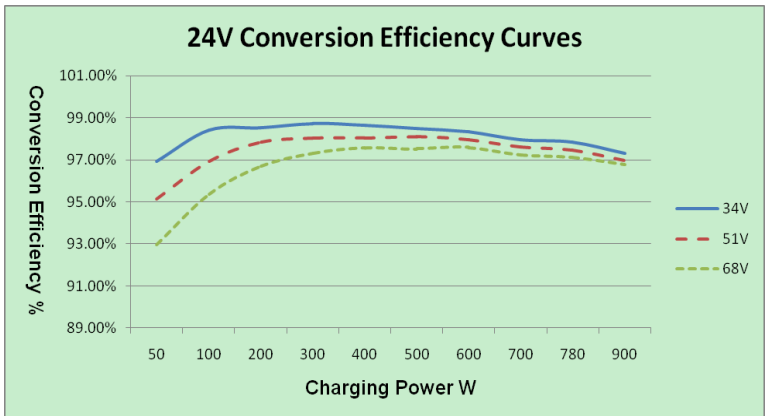

Model: XTRA4210N

1. Solar module MPP voltage (17 V, 34 V)/Minor system voltage (12 V)

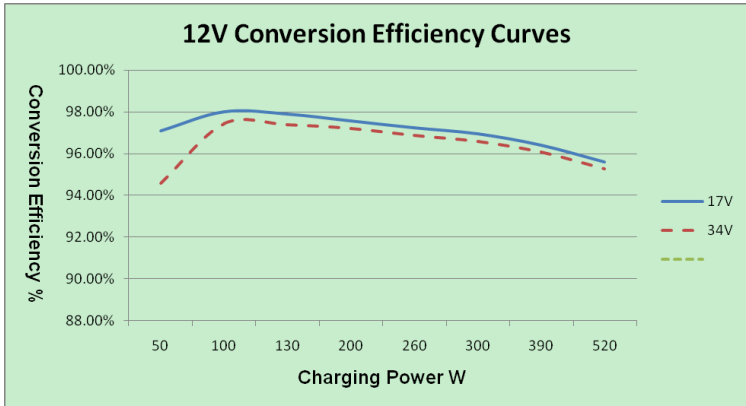

2. Solar module MPP voltage (34 V, 51 V, 68 V)/Invariable system voltage (24 V)

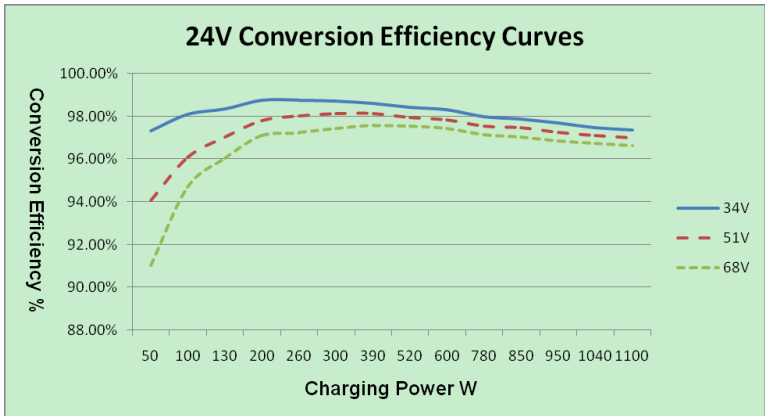

Annex II Diagram and dimensions

XTRA1210N (mm)

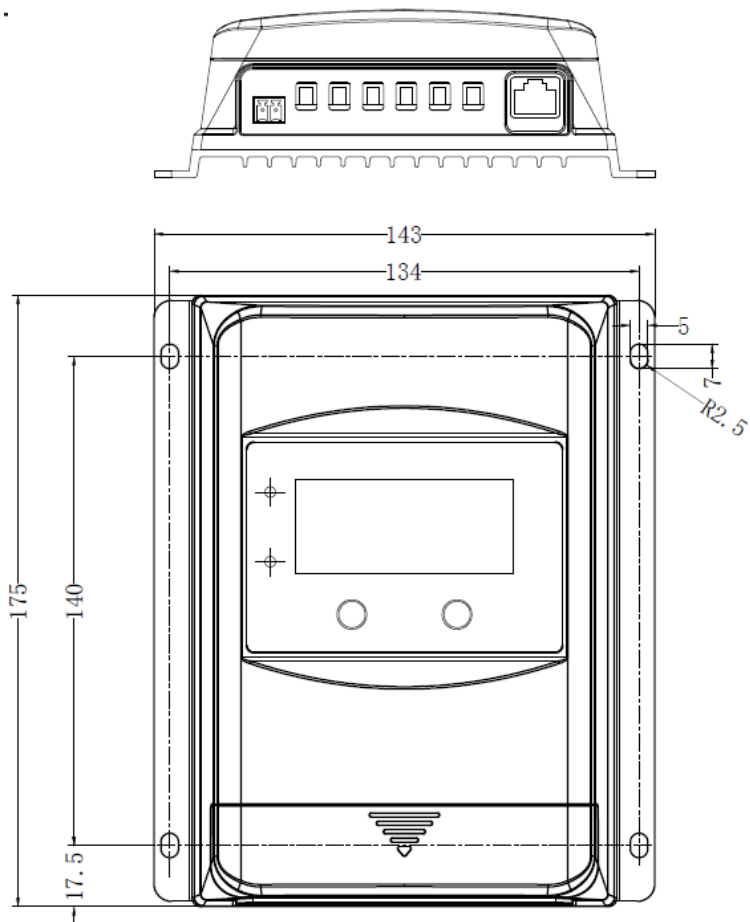

XTRA2210N (mm)

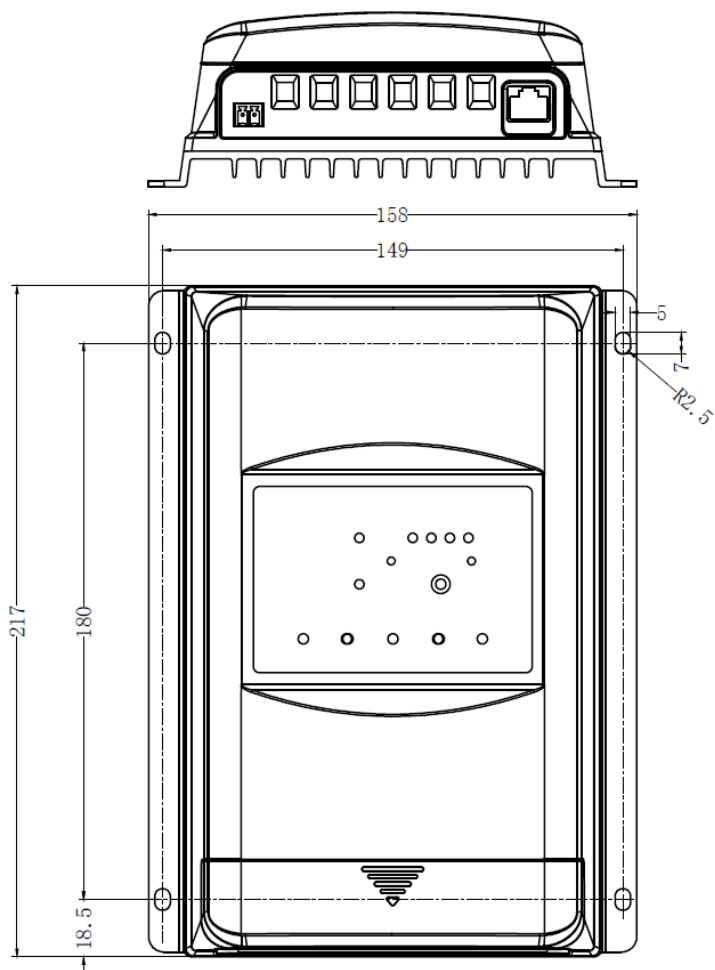

XTRA3210N (mm)

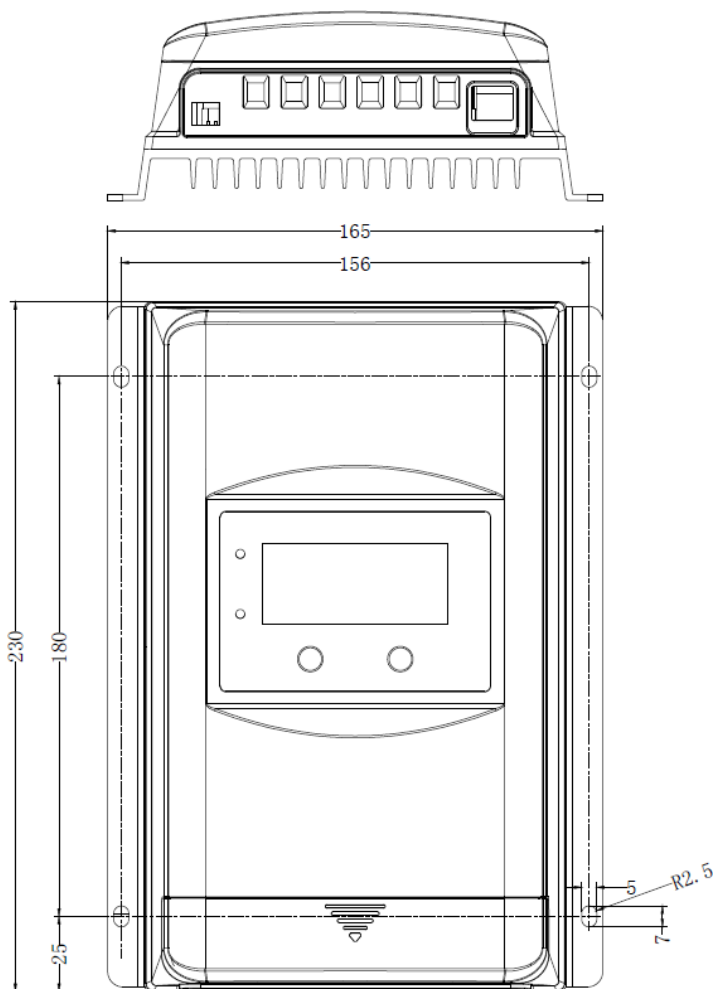

XTRA4210N (mm)

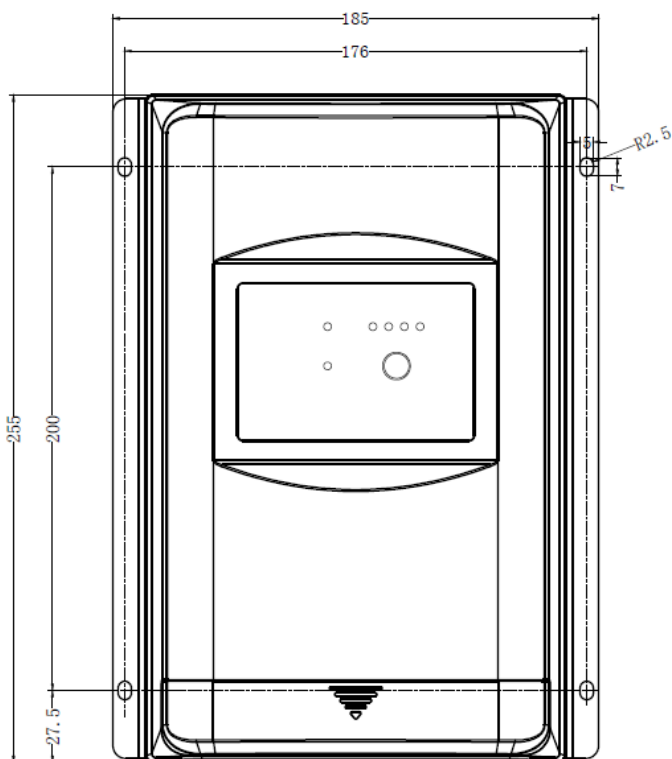
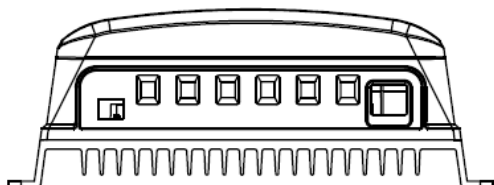

Any changes without prior notice! Version

number: 1.0*